



HAI

Hammerer Aluminium Industries

Hammerer Aluminium Industries GmbH



EXPECT MORE!

PROGRAMM FREI VERKÄUFLICHER KÜHLKÖRPER

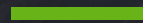

ÜBERSICHT VERFÜGBARE ABMESSUNGEN



45 mm x 80 mm	300 mm x 15 mm
100 mm x 40 mm	300 mm x 40 mm
111,5 mm x 67,5 mm	300 mm x 60 mm
150 mm x 50 mm	300 mm x 83 mm
160 mm x 40 mm	300 mm x 84 mm
200 mm x 15 mm	306,4 mm x 40 mm
200 mm x 25 mm	320 mm x 40 mm
200 mm x 9,9 mm	380 mm x 25 mm
200 mm x 40 mm	400 mm x 40 mm
216 mm x 83 mm	500 mm x 83 mm
245,6 mm x 25 mm	



STANDARDKÜHLKÖRPER



Abmessung: 45 mm x 80 mm
Material: EN AW 6060 T66
Gewicht: 4,46 kg/m
Profil - Nr.: 615607

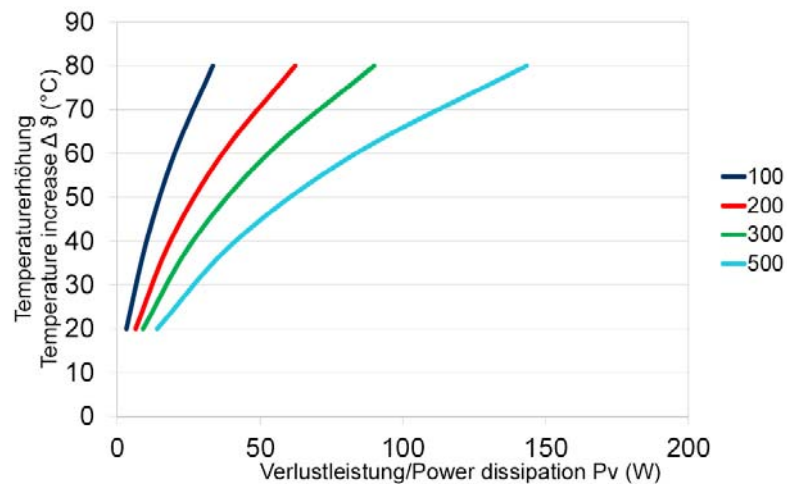
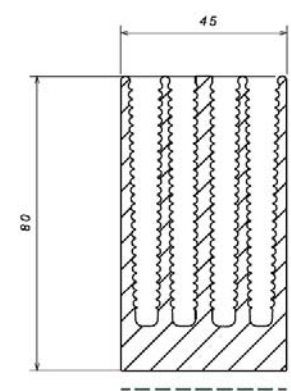

STANDARDKÜHLKÖRPER



Abmessung: 100 mm x 40 mm
Material: EN AW 6060 T66
Gewicht: 5,43 kg/m
Profil - Nr.: 612425

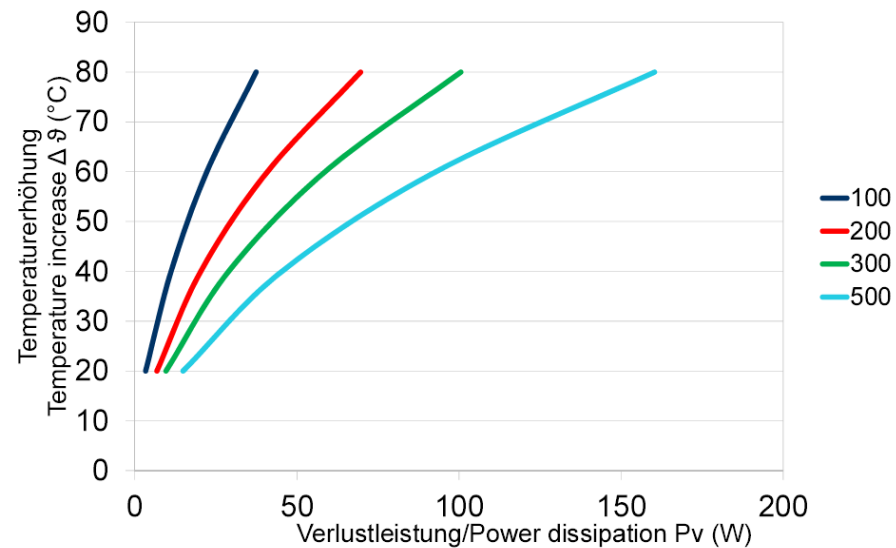
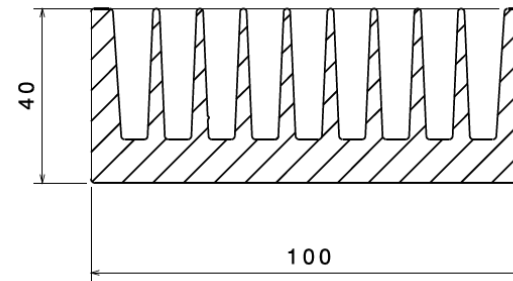

STANDARDKÜHLKÖRPER



Abmessung: 111,5 mm x 67,5 mm
Material: EN AW 6060 T66
Gewicht: 8,66 kg/m
Profil – Nr.: 615295

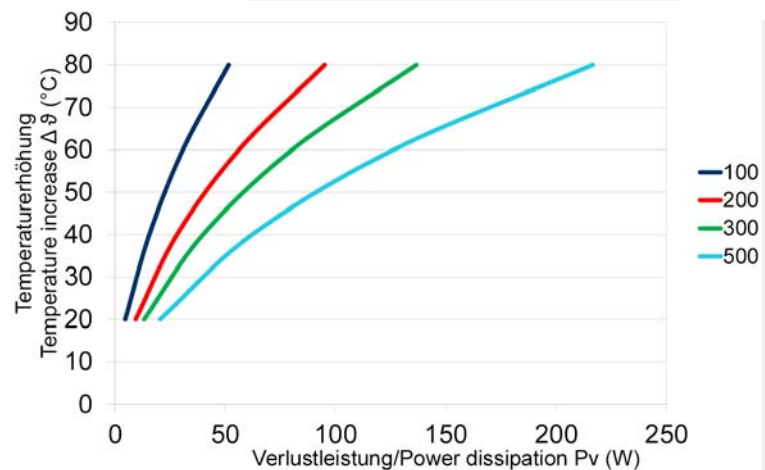
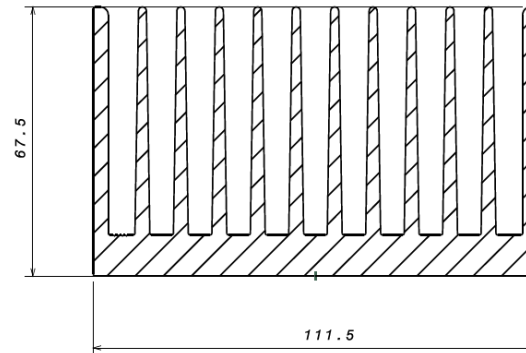

STANDARDKÜHLKÖRPER



Abmessung: 150 mm x 50 mm
Material: EN AW 6060 T66
Gewicht: 9,59 kg/m
Profil – Nr.: 615104

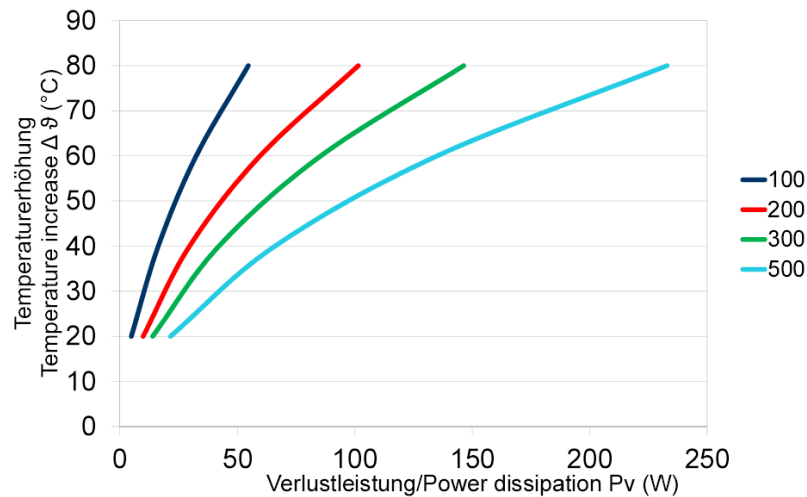
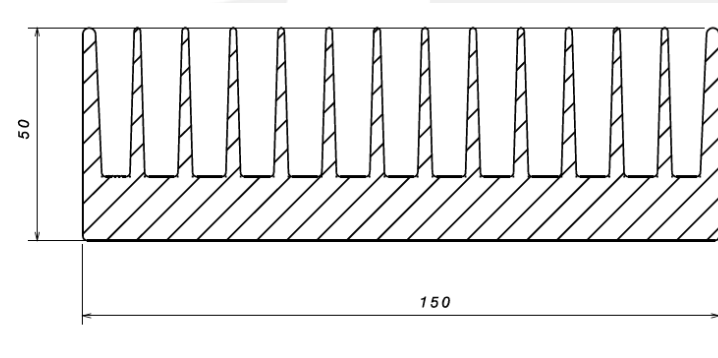

STANDARDKÜHLKÖRPER



Abmessung: 160 mm x 40 mm
Material: EN AW 6060 T66
Gewicht: 8,01 kg/m
Profil – Nr.: 614501

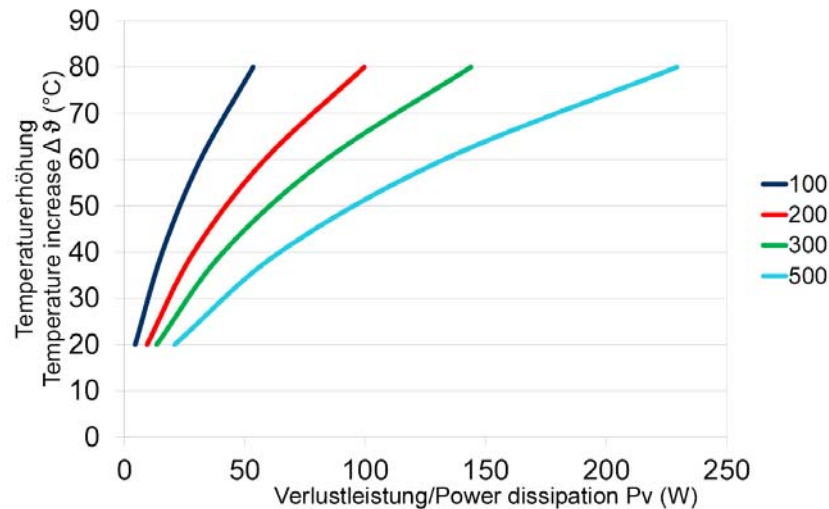
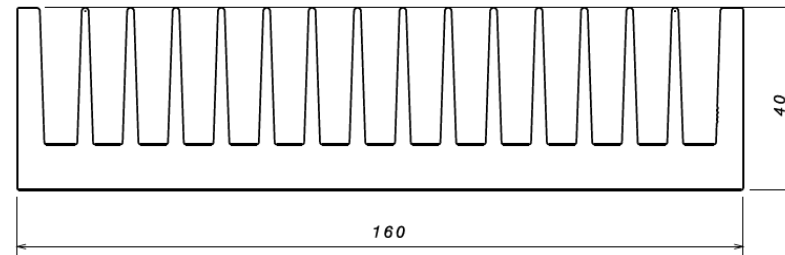

STANDARDKÜHLKÖRPER



Abmessung: 200 mm x 15 mm
Material: EN AW 6060 T66
Gewicht: 3,600 kg/m
Profil – Nr.: 615588

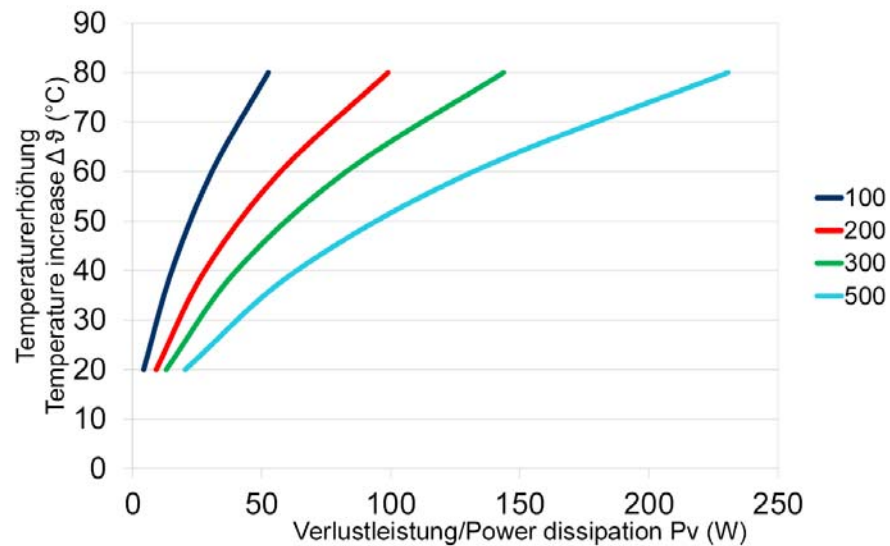
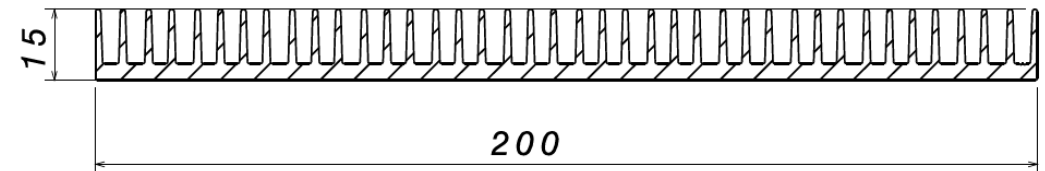

STANDARDKÜHLKÖRPER



Abmessung: 200 mm x 25 mm
Material: EN AW 6060 T66
Gewicht: 4,690 kg/m
Profil – Nr.: 699586

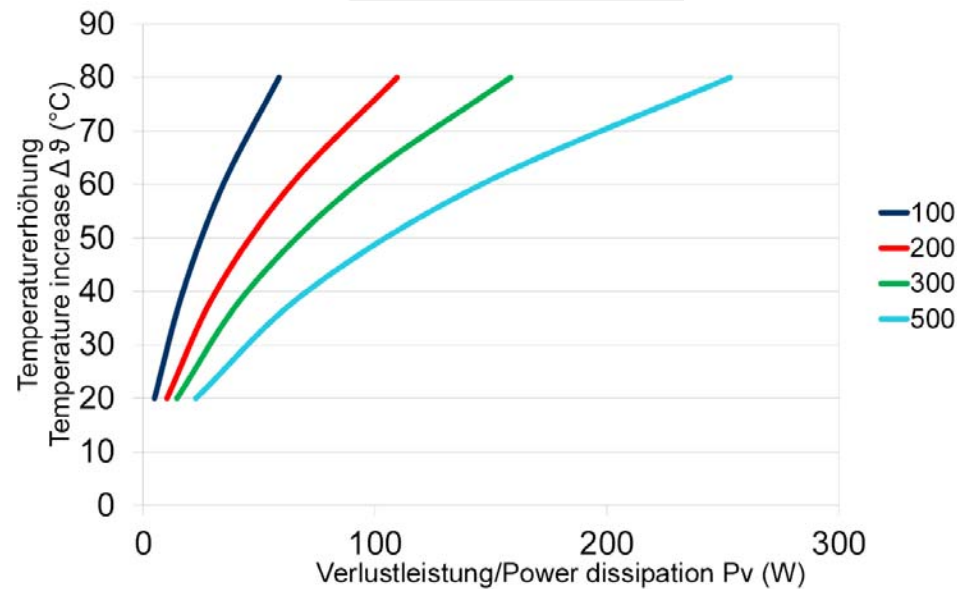
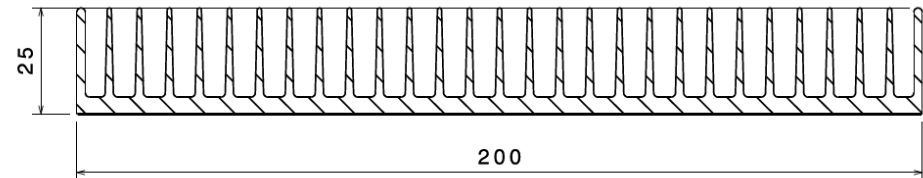

STANDARKÜHLKÖRPER



Abmessung: 200 mm x 40 mm
Material: EN AW 6060 T66
Gewicht: 10,330 kg/m
Profil – Nr.: 699955

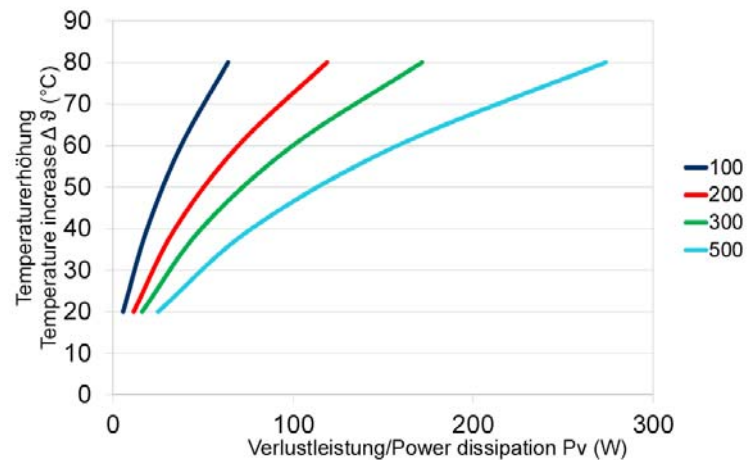
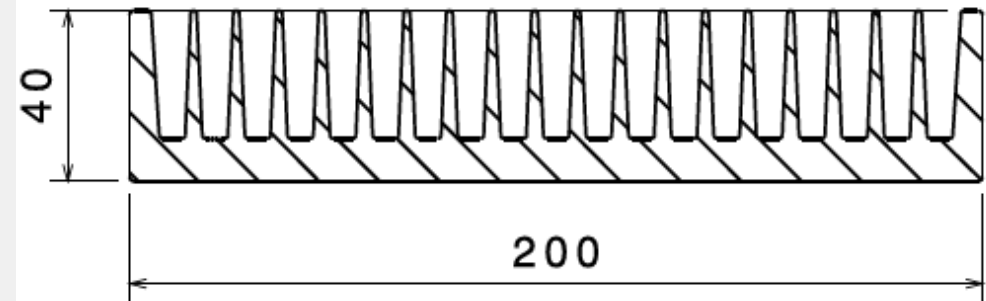

STANDARDKÜHLKÖRPER



Abmessung: 200 mm x 40 mm
Material: EN AW 6060 T66
Gewicht: 9,245 kg/m
Profil – Nr.: 616060

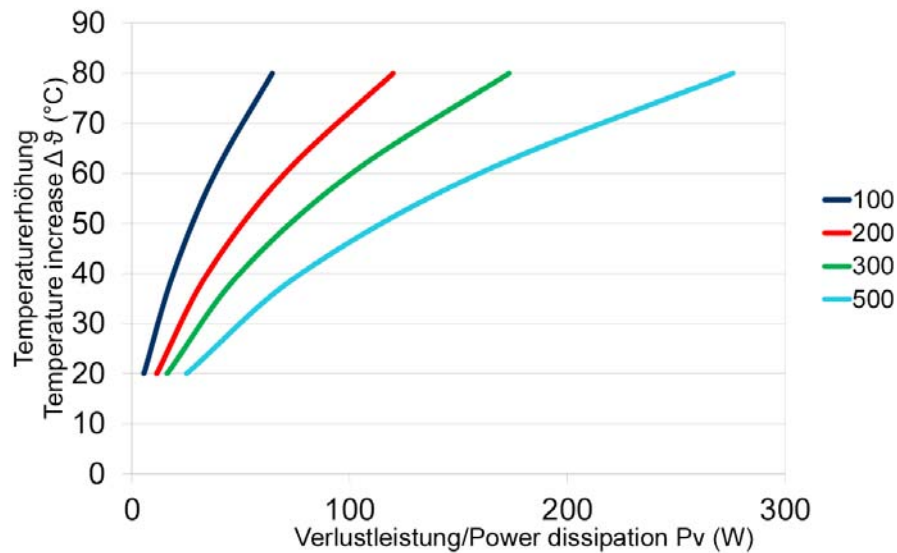
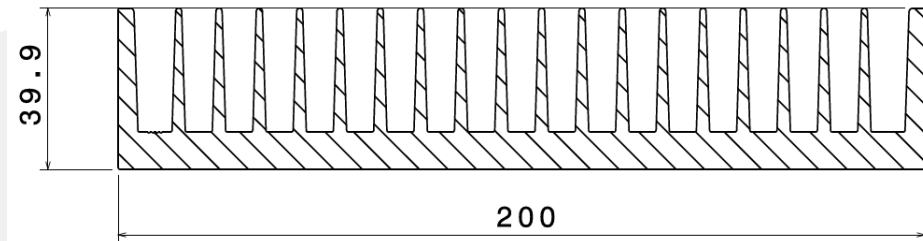

STANDARDKÜHLKÖRPER



Abmessung: 216 mm x 83 mm
Material: EN AW 6060 T66
Gewicht: 18,06 kg/m
Profil – Nr.: 615028

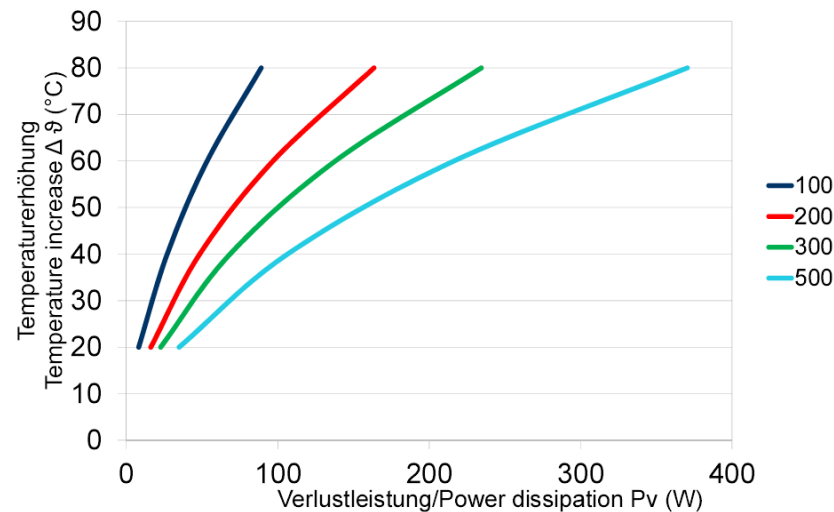
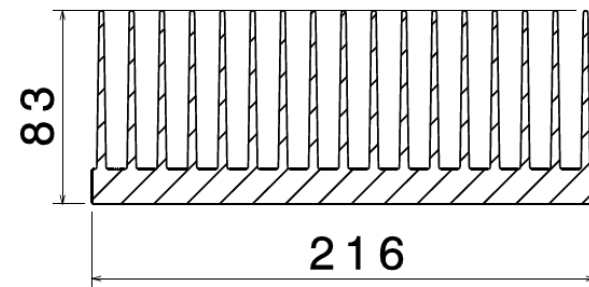

STANDARDKÜHLKÖRPER



Abmessung: 245,6 mm x 25 mm
Material: EN AW 6060 T66
Gewicht: 6,37 kg/m
Profil – Nr.: 612144

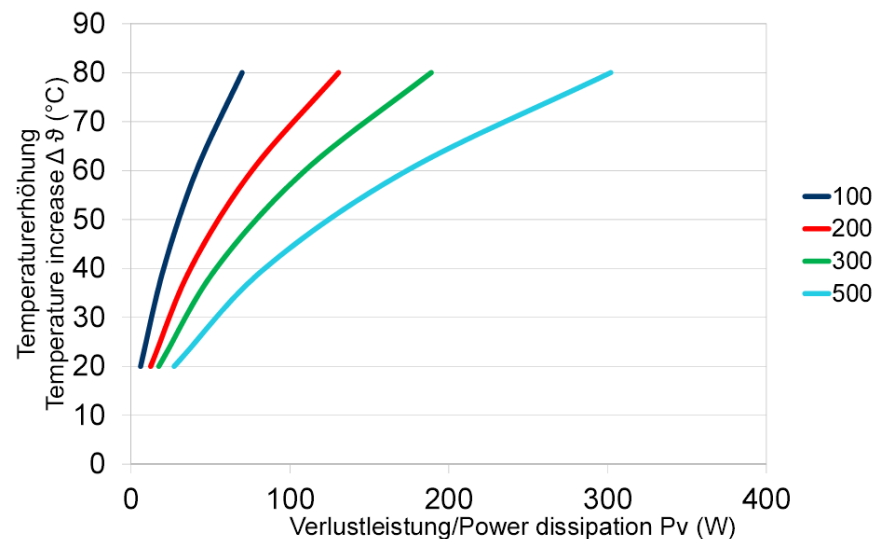
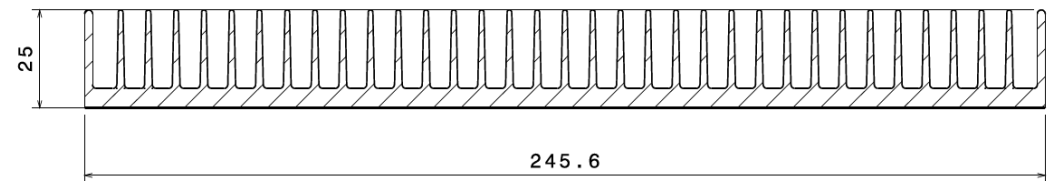

STANDARDKÜHLKÖRPER



Abmessung: 300 mm x 15 mm
Material: EN AW 6060 T66
Gewicht: 5,403 kg/m
Profil - Nr.: 612210

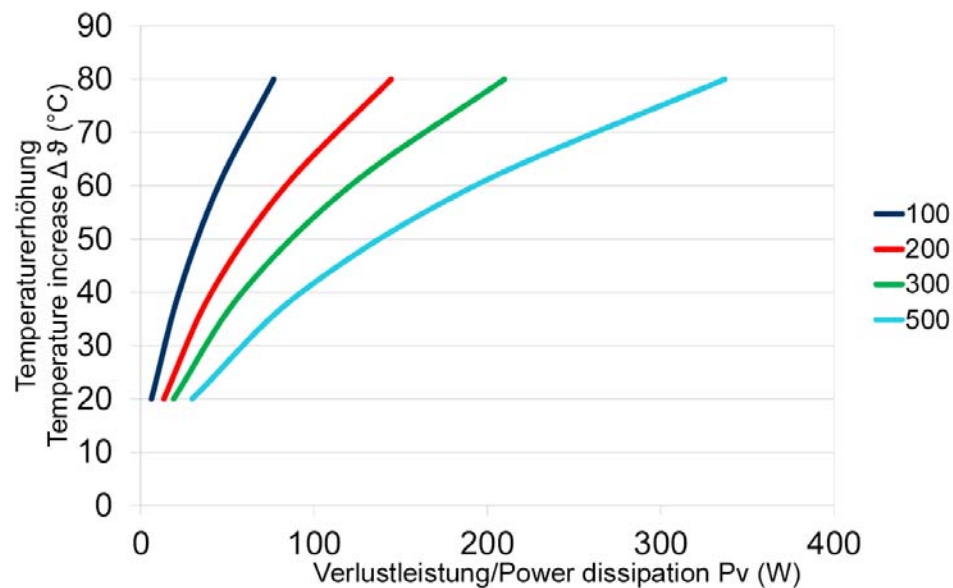
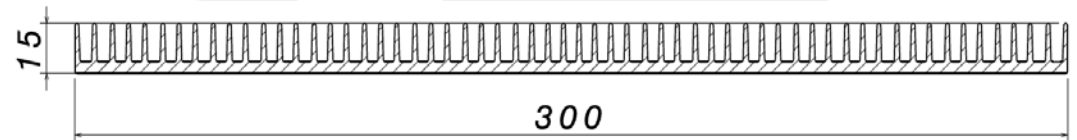

STANDARDKÜHLKÖRPER



Abmessung: 300 mm x 40 mm
Material: EN AW 6060 T66
Gewicht: 15,88 kg/m
Profil - Nr.: 699096

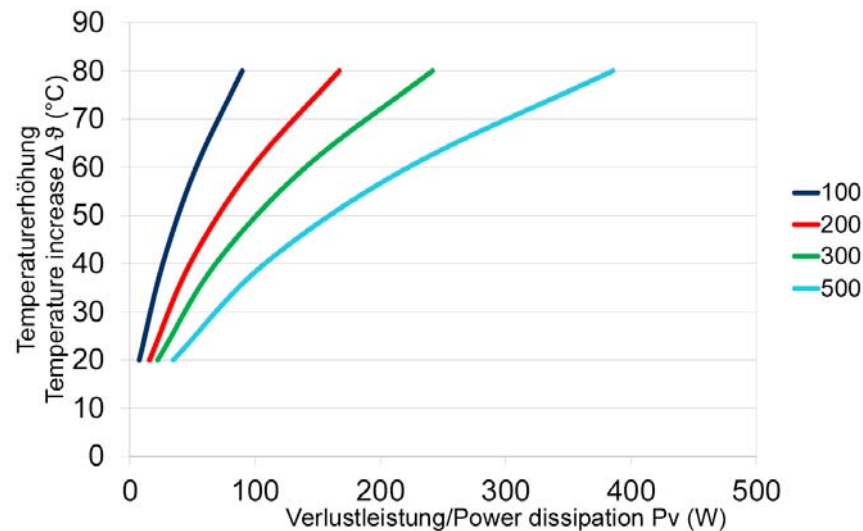
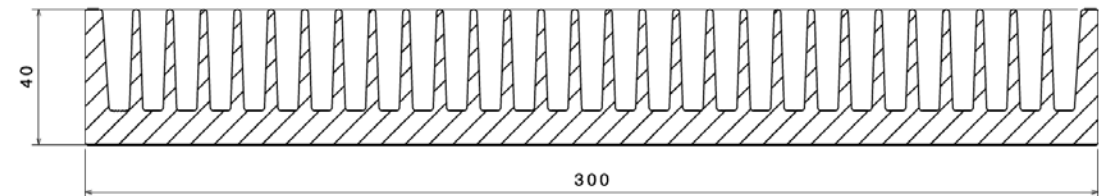

STANDARDKÜHLKÖRPER



Abmessung: 300 mm x 60 mm
Material: EN AW 6060 T66
Gewicht: 18,325 kg/m
Profil – Nr.: 616371

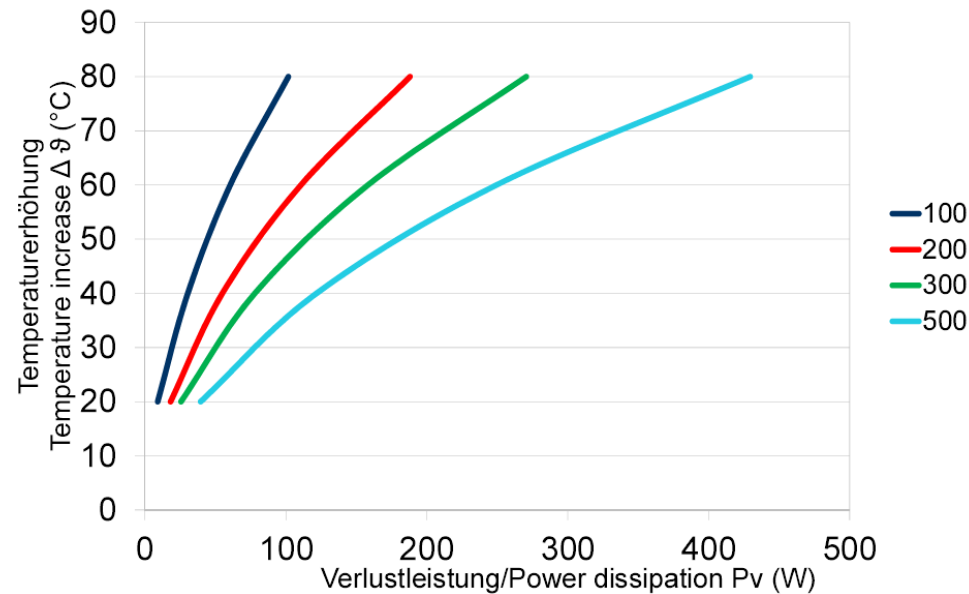
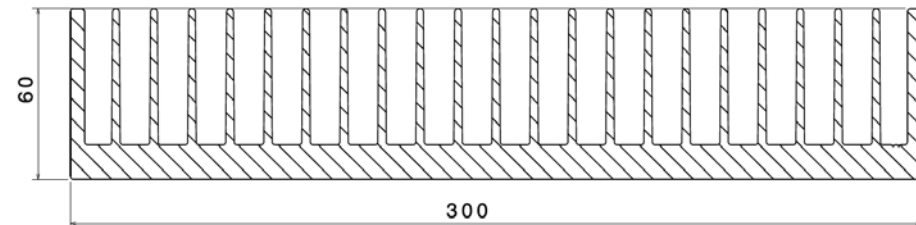

STANDARDKÜHLKÖRPER



Abmessung: 300 mm x 83 mm
Material: EN AW 6060 T66
Gewicht: 23,84 kg/m
Profil – Nr.: 615050

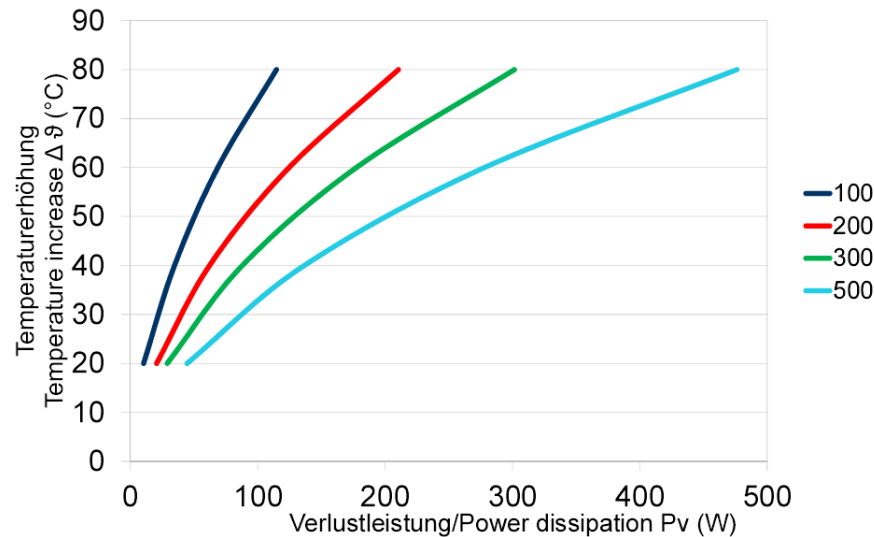
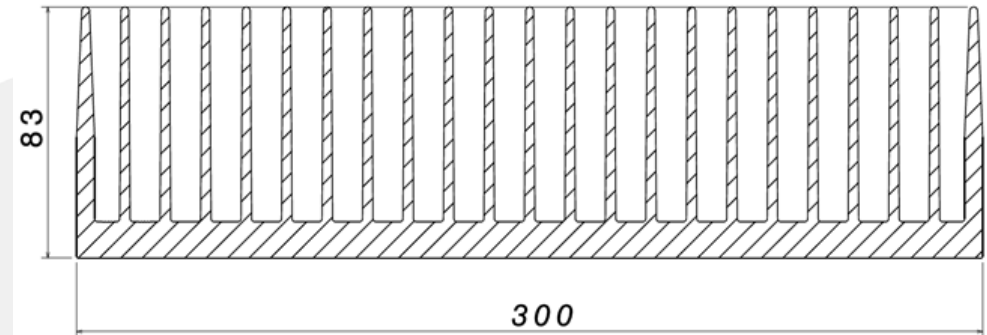

STANDARKÜHLKÖRPER



Abmessung: 300 mm x 84 mm
Material: EN AW 6060 T66
Gewicht: 28,02 kg/m
Profil – Nr.: 615791

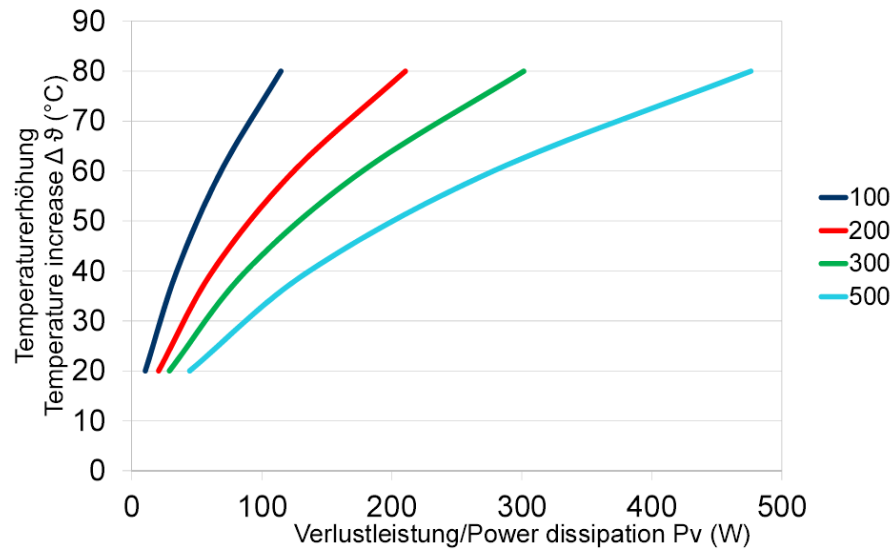
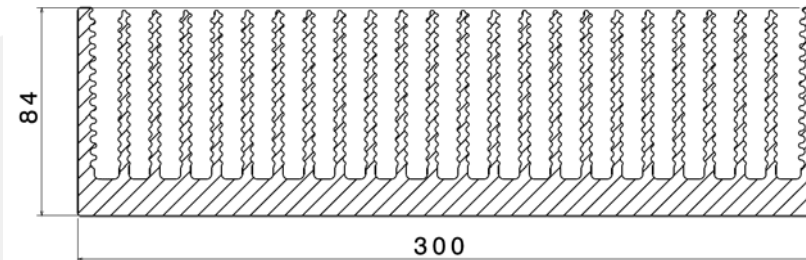

STANDARDKÜHLKÖRPER



Abmessung: 306,4 mm x 40 mm
Material: EN AW 6060 T66
Gewicht: 12,36 kg/m
Profil – Nr.: 614473

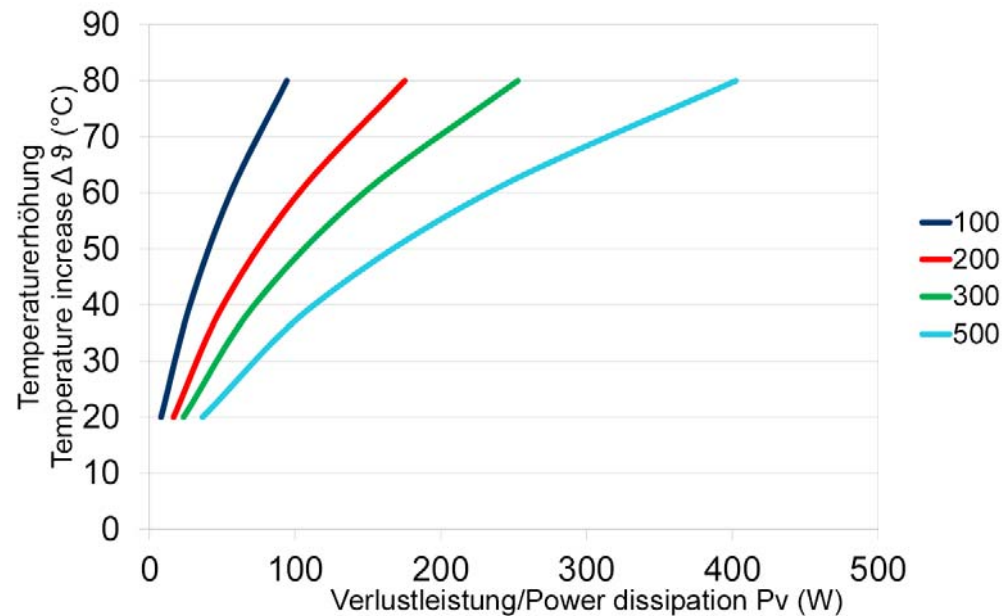
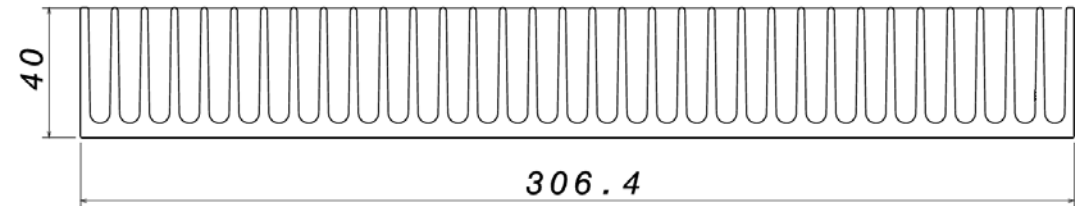

STANDARDKÜHLKÖRPER



Abmessung: 320 mm x 40 mm
Material: EN AW 6060 T66
Gewicht: 10,8 kg/m
Profil – Nr.: 612760

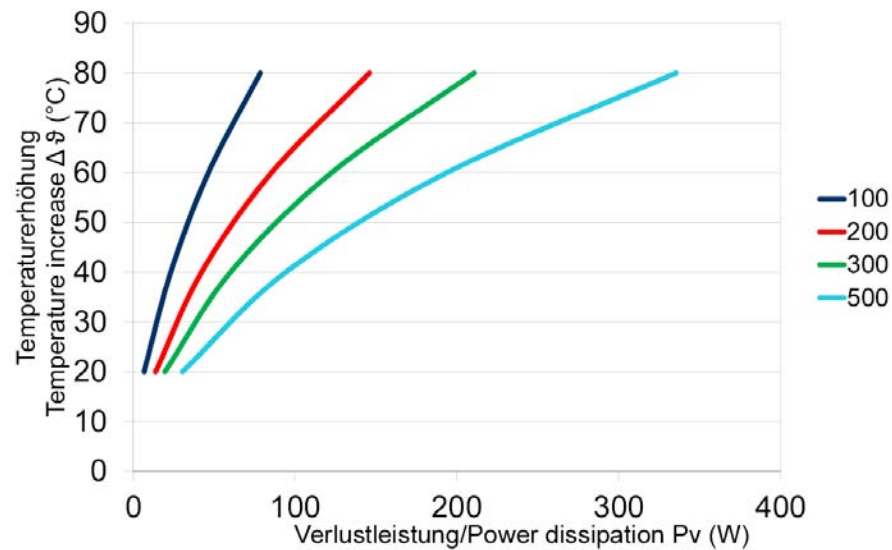
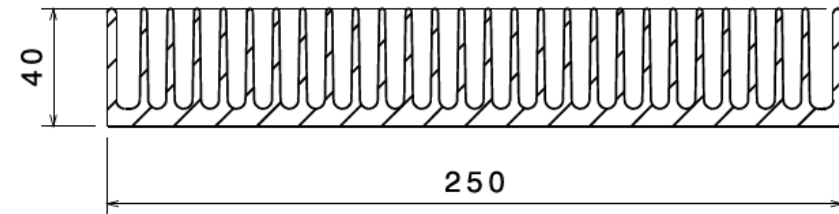

STANDARKÜHLKÖRPER



Abmessung: 380 mm x 25 mm
Material: EN AW 6060 T66
Gewicht: 11,96 kg/m
Profil – Nr.: 614942

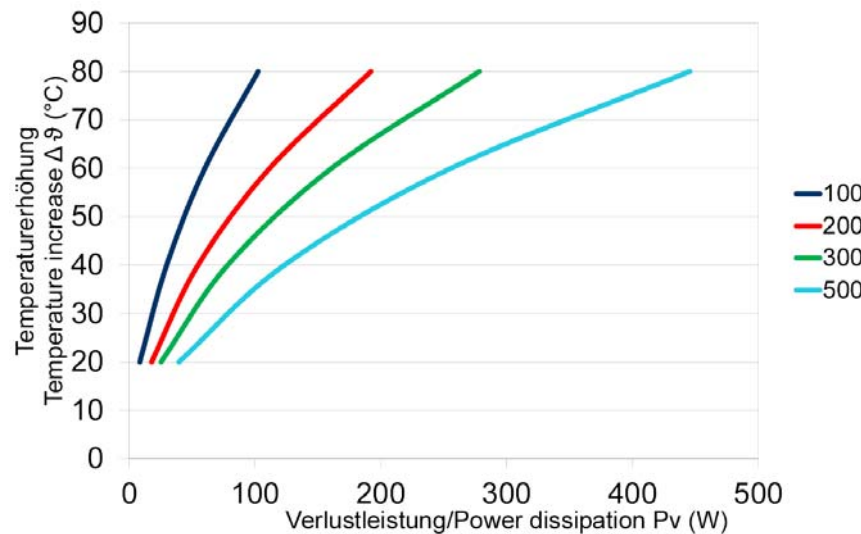
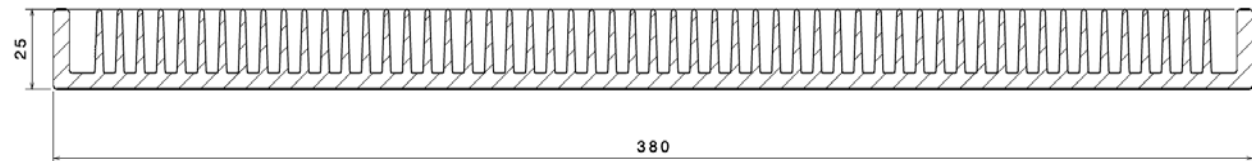

STANDARDKÜHLKÖRPER



Abmessung: 400 mm x 40 mm
Material: EN AW 6060 T66
Gewicht: 20,9 kg/m
Profil – Nr.: 616169

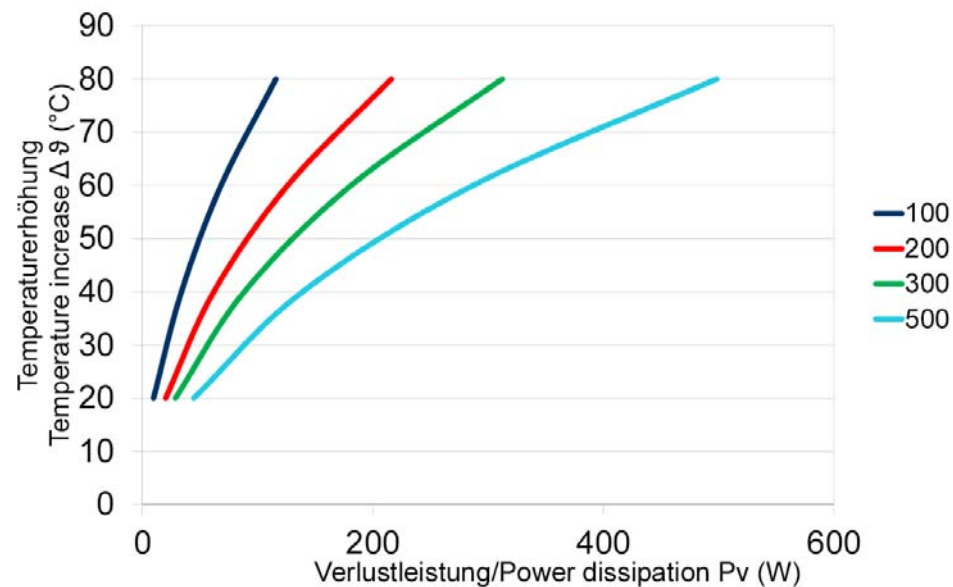
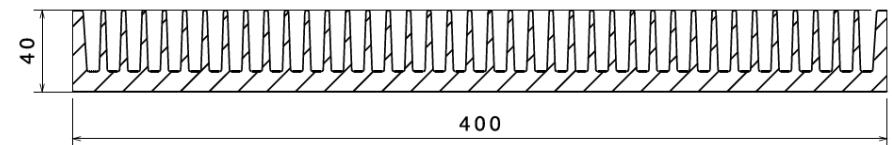

STANDARKÜHLKÖRPER



Abmessung: 500 mm x 83 mm
Material: EN AW 6060 T66
Gewicht: 44,74 kg/m
Profil - Nr.: 615910 / 615911

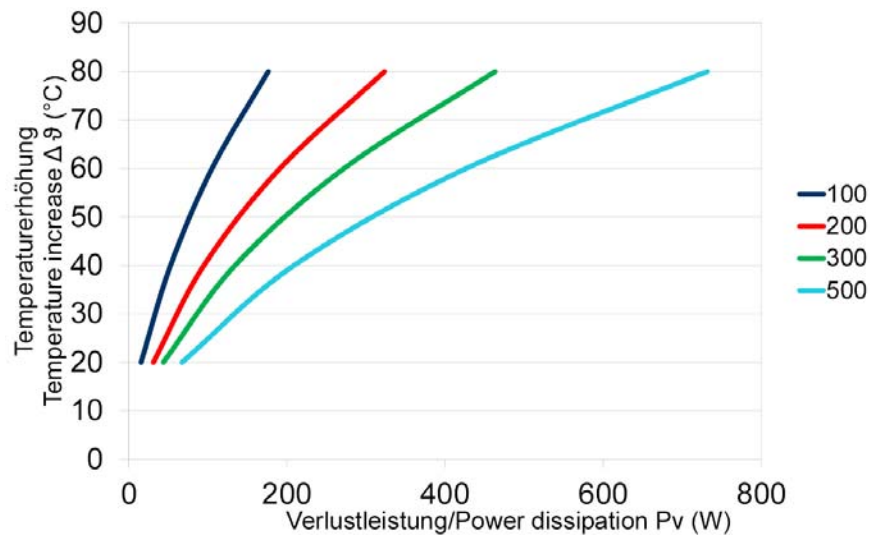
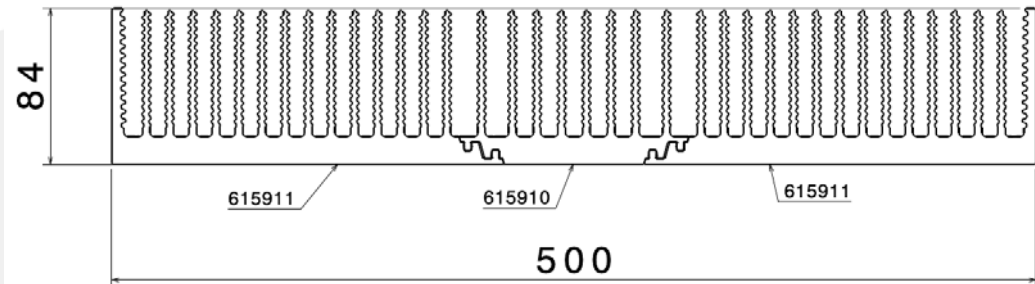

STANDARDKÜHLKÖRPER

LIEFERBEDINGUNGEN



LIEFERUNG

Unsere Lieferungen
erfolgen frei Haus!



PREISE

Wir unterbreiten
Ihnen gerne ein
individuelles Angebot!



MINDESTABNAHME

ab 1.000 kg



STANDARKÜHLKÖRPER

LIEFERBEDINGUNGEN



OBERFLÄCHE

pressblank

LIEFERLÄNGEN

nach Wahl zwischen
3.000 bis 6.000
+ 20 mm

TECHN. AUSFÜHRUNG

Profilzeichnungen stehen
mit allen Maßen und
Toleranzen zur Verfügung!

